

Issue/RevNo	Revision note	Date	Signature	Checked
1.0	Original Issue	01/04/2014	MBM	TNB

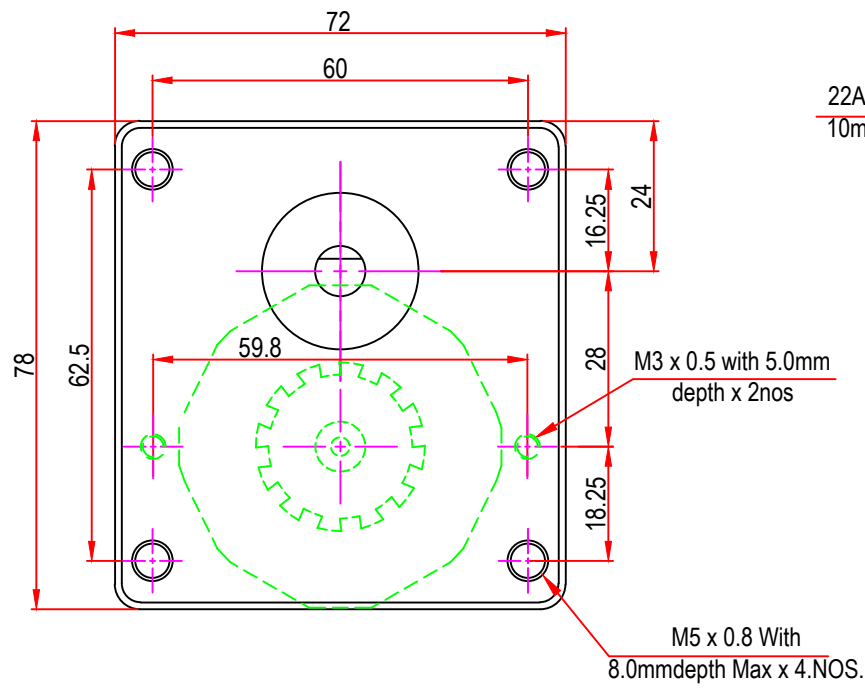

22AWG Leads length 200mm
10mm ends stripped

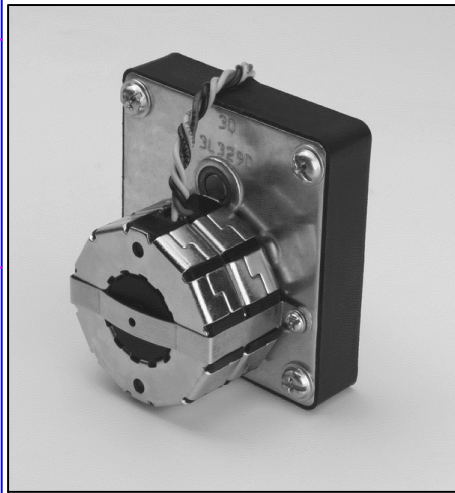
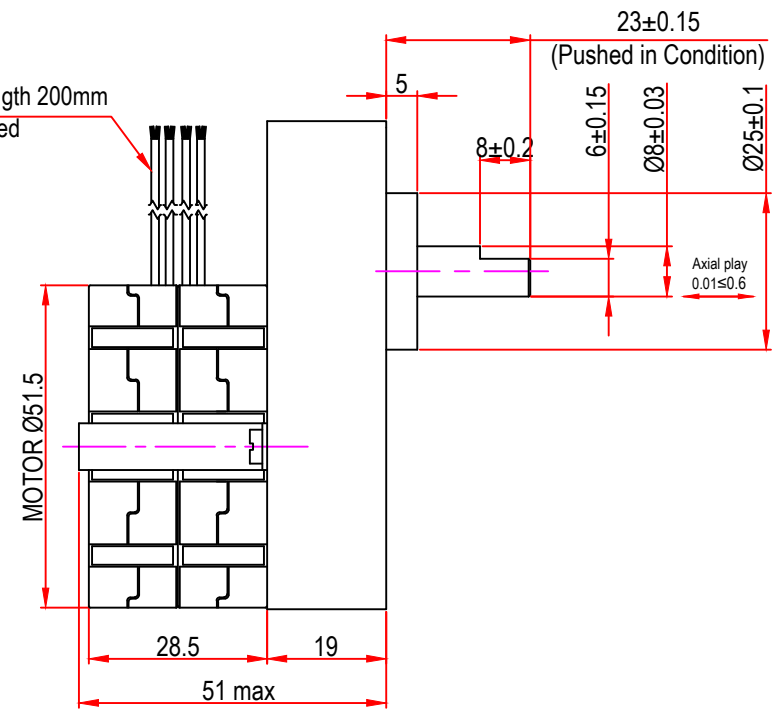

		Motion Drivetrionics Pvt Ltd		
Itemref	MTS4a4	Article No./Reference		
Designed by MBM	Checked by TNB	Approved by TNB	Date 01/04/2014	Scale do not scale
BRAND - MECHTEX Navi Mumbai - 400 709.		Assembly Drawing		
F-MKT-022 VER 3.0		Edition	Sheet 1 of 1	