

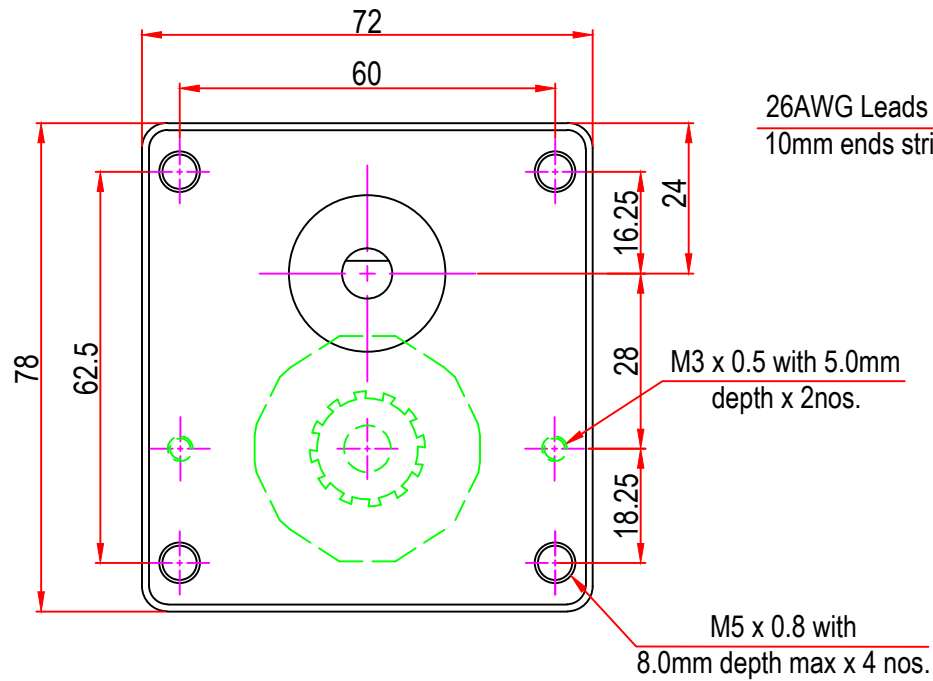

Issue/RevNo	Revision note	Date	Signature	Checked
1.0	Original Issue	01/04/2014	MBM	TNB

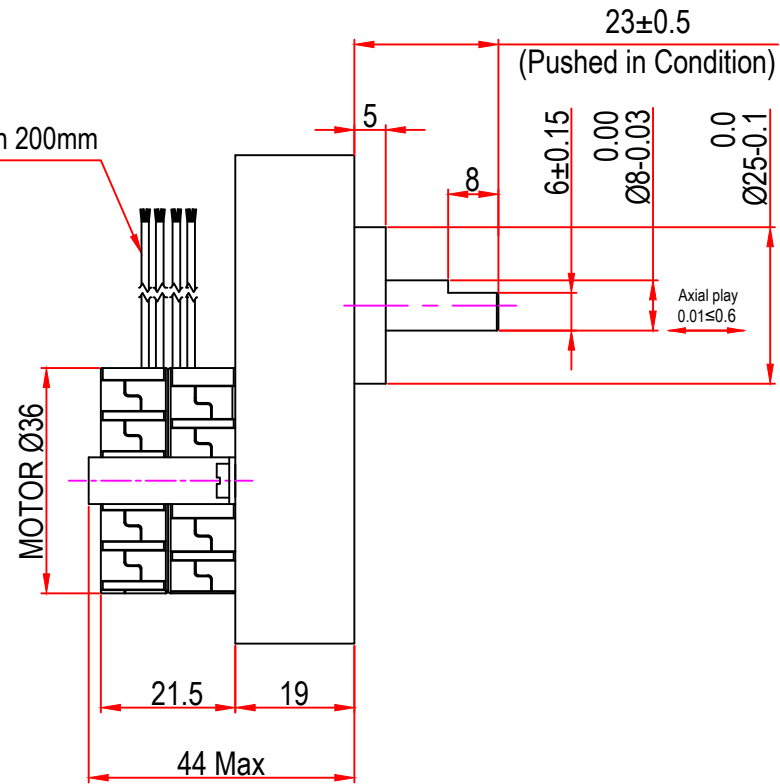

26AWG Leads length 200mm
10mm ends stripped



 Motion Drivetrionics Pvt Ltd				
Itemref	MTR3a4		Article No./Reference	
Designed by MBM	Checked by TNB	Approved by TNB	Date 01/04/2014	Scale do not scale
BRAND - MECHTEX Navi Mumbai - 400 709.			Assembly Drawing	
F-MKT-022 VER 3.0			Edition	Sheet 1 of 1