

Issue/RevNo	Revision note	Date	Signature	Checked
1.0	Original Issue	01/04/2014	MBM	TNB

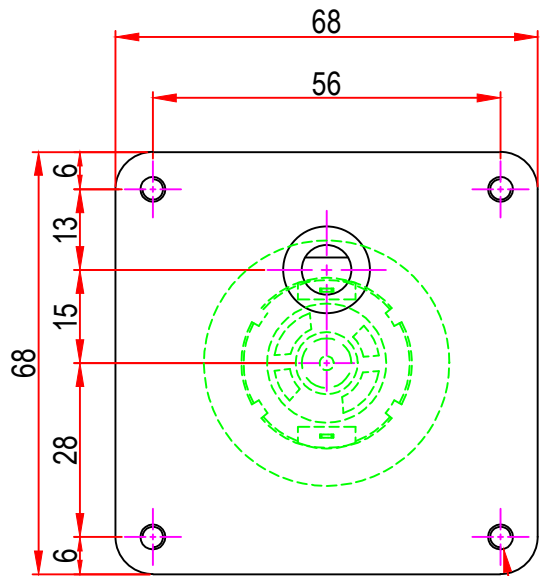

Adopter Plate (Ø38.6 x4.5mm)

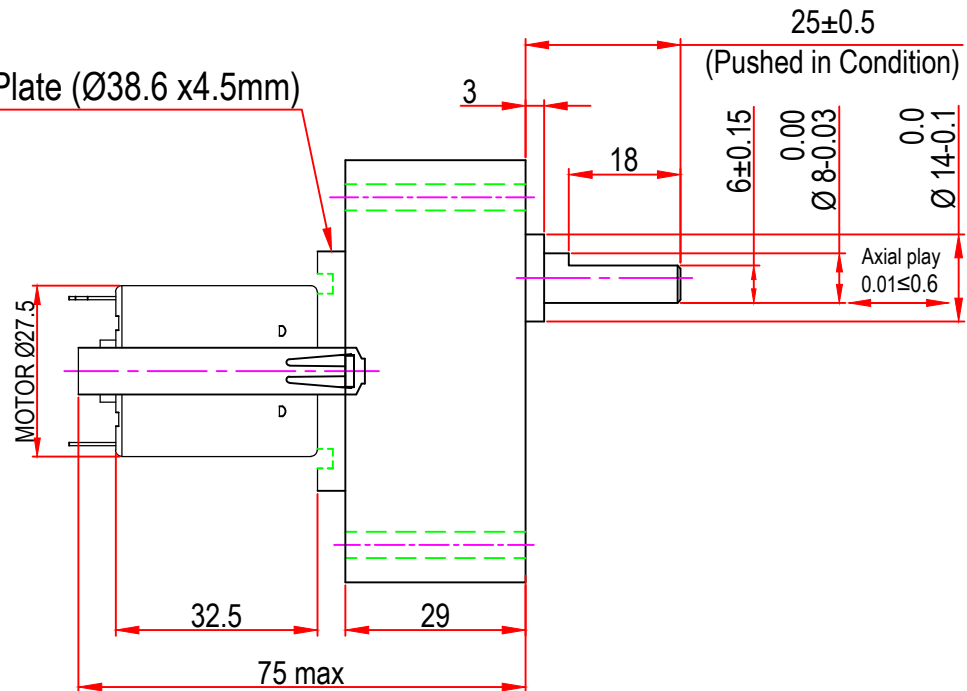

M4 x 0.7 with 8.0mm depth x 4nos  
other on request.



		Motion Drivetrionics Pvt Ltd		
Itemref	DC28GBU	Article No./Reference		
Designed by MBM	Checked by TNB	Approved by TNB	Date 01/04/2014	Scale do not scale
BRAND - MECHTEX Navi Mumbai - 400 709.		Assembly Drawing		
F-MKT-022 VER 3.0		Edition		Sheet 1 of 1